

# **MGate 5103**

## **Quick Installation Guide**

---

**Edition 1.0, December 2017**

### **Technical Support Contact Information** **[www.moxa.com/support](http://www.moxa.com/support)**

**Moxa Americas:**

Toll-free: 1-888-669-2872  
Tel: 1-714-528-6777  
Fax: 1-714-528-6778

**Moxa China (Shanghai office):**

Toll-free: 800-820-5036  
Tel: +86-21-5258-9955  
Fax: +86-21-5258-5505

**Moxa Europe:**

Tel: +49-89-3 70 03 99-0  
Fax: +49-89-3 70 03 99-99

**Moxa Asia-Pacific:**

Tel: +886-2-8919-1230  
Fax: +886-2-8919-1231

**Moxa India:**

Tel: +91-80-4172-9088  
Fax: +91-80-4132-1045



© 2017 Moxa Inc. All rights reserved.

**P/N: 1802051030010**



## Overview

The MGate 5103 is an industrial Ethernet gateway for Modbus RTU/ASCII/TCP, EtherNet/IP, and PROFINET network communications.

## Package Checklist

Before installing the MGate 5103, verify that the package contains the following items:

- 1 MGate 5103 gateway
- 1 serial cable: DBL-RJ45F9-150
- Documentation
- Quick installation guide (printed)
- Warranty card

*Please notify your sales representative if any of the above items is missing or damaged.*

### **Optional Accessories (can be purchased separately)**

- **CBL-F9M9-150:** DB9-female-to-DB9-male serial cable, 150 cm
- **CBL-F9M9-20:** DB9-female-to-DB9-male serial cable, 20 cm
- **CBL-RJ45SF9-150:** RJ45-to-DB9-female shielded serial cable, 150 cm
- **ADP-RJ458P-DB9F:** DB9-female-to-RJ45 connector
- **ADP-RJ458P-DB9F-ABC01:** DB9-female-to-RJ45 connector
- **Mini DB9F-to-TB:** DB9-female-to-terminal-block connector

## Hardware Introduction

### LED Indicators

LED	Color	Description
Ready	Off	Power is off or a fault condition exists
	Green	Steady: Power is on, and the MGate is functioning normally
	Red	Steady: Power is on, and the MGate is booting up
		Blinking slowly: Indicates an IP conflict, or the DHCP or BOOTP server is not responding properly
MB/EIP	Off	Modbus: No communication with Modbus device EtherNet/IP: No I/O data exchange
	Green (Blinking)	Modbus: Communication in progress EtherNet/IP: I/O data is exchanging
	Red (Blinking)	Communication error <i>When MGate 5103 acts as Modbus Client/Master:</i> <ol style="list-style-type: none"> <li>1. Slave device returned an error (exception)</li> <li>2. Received a frame error (parity error, checksum error)</li> <li>3. Timeout (slave device is not responding or TCP connection timed out)</li> </ol> <i>When MGate 5103 acts as Modbus Server/Slave:</i> <ol style="list-style-type: none"> <li>1. Received invalid function code</li> <li>2. Master accessed invalid register address or coil addresses</li> <li>3. Received frame error (parity error, checksum error)</li> </ol> <i>When MGate 5103 acts as EtherNet/IP adapter:</i> <ol style="list-style-type: none"> <li>1. Refuses connection due to incorrect configuration</li> </ol>
		Off
PN	Green (Blinking)	PROFINET I/O is connected and the controller is in RUN mode
	Red (Blinking)	PROFINET I/O is connected, but the controller is in STOP mode
	Off	No connection with PROFINET I/O controller

## Dimensions

Unit: mm (inch)

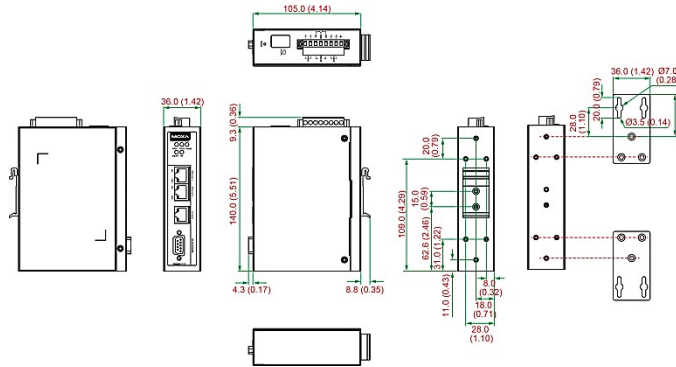

## Reset Button

Restore the MGate to factory default settings by using a pointed object (such as a straightened paper clip) to hold the reset button down until the Ready LED stops blinking (approximately five seconds).

## Pull-up, Pull-down, and Terminator for RS-485

Beneath the MGate 5103's top cover, you will find DIP switches to adjust each serial port's pull-up resistor, pull-down resistor, and terminator.

SW	1	2	3
	ON	Pull-up resistor 1 k $\Omega$	Pull-down resistor 1 k $\Omega$
OFF	150 k $\Omega$ *	150 k $\Omega$ *	—*

\*Default

## Hardware Installation Procedure

1. Connect the power adapter. Connect the 12-48 VDC power line or DIN-rail power supply to the MGate 5103's terminal block.
2. Use a serial cable to connect the MGate to the Modbus device.
3. Use an Ethernet cable to connect the MGate to the PROFINET IO controller.
4. The MGate 5103 is designed to be attached to a DIN rail or mounted on a wall. For DIN-rail mounting, push down the spring and properly attach it to the DIN rail until it "snaps" into place. For wall mounting, install the wall-mounting kit (optional) first and then screw the device onto the wall.

The following figure illustrates the two mounting options:

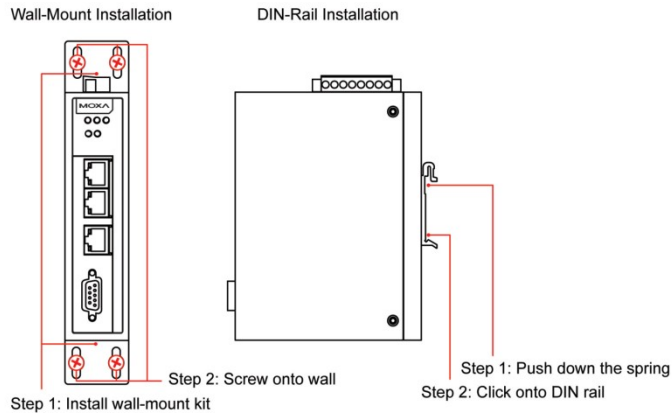

## Software Installation Information

The MGate 5103 also supports login via a web browser.

Default IP address: **192.168.127.254**

Default account: **admin**

Default password: **moxa**

## Pin Assignments

### Modbus Serial Port (Male DB9)

Pin	RS-232	RS-422/ RS-485 (4W)	RS-485 (2W)
1	DCD	TxD-(A)	-
2	RXD	TxD+(B)	-
3	TXD	RxD+(B)	Data+(B)
4	DTR	RxD-(A)	Data-(A)
5*	GND	GND	GND
6	DSR	-	-
7	RTS	-	-
8	CTS	-	-
9	-	-	-

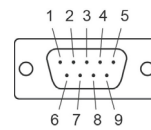

\*Signal ground

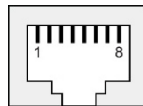

### Ethernet Port (RJ45)

Pin	Signal
1	Tx+
2	Tx-
3	Rx+
6	Rx-

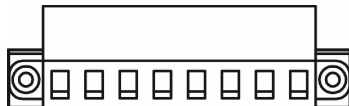

### Power Input and Relay Output Pinouts



	V2+	V2-				V1+	V1-
Shielded Ground	DC Power Input 2	DC Power Input 2	N.O.	Common	N.C.	DC Power Input 1	DC Power Input 1

## Specifications

Power Requirements	
Power Input	12 to 48 VDC
Power Consumption	455 mA @ 12 VDC, 125 mA @ 48 VDC
Operating Temperature	Standard models: 0 to 60°C (32 to 140°F) Wide temp. models: -40 to 75°C (-40 to 167°F)
Ambient Relative Humidity	5 to 95% RH
Dimensions	36 x 105 x 140 mm (1.42 x 4.13 x 5.51 in)
Reliability	
Alert Tools	Built-in buzzer and RTC
MTBF	859,422 hrs.



- DEMKO Certification number: 13 ATEX 1307610X  
IEC Certification Number: IECEx UL 13.0051X;
- Ambient Temperature Range:  
0°C to 60°C (for models without suffix -T)  
-40°C to 75°C (for models with suffix -T only)
- Certification String: Ex nA nC IIC T3 Gc
- Standards Covered: EN 60079-0:2013+A11:2013/IEC 60079-0 6th Ed. AND EN 60079-15:2010/IEC 60079-15 4th Ed.
- The conditions of safe use:
  - Ethernet Communications Devices are intended for mounting in a tool-accessible IP54 enclosure and use in an area of not more than pollution degree 2 as defined by IEC/EN 60664-1.
  - Conductors suitable for use in an ambient temperature greater than 86°C must be used for the power supply terminal.
  - A 4mm<sup>2</sup> conductor must be used when a connection to the external grounding screw is utilized.
  - Provisions shall be made, either in the equipment or external to the equipment, to prevent the rated voltage from being exceeded by the transient disturbances of more than 140% of the peak-rated voltage.

Terminal block (plug matched with socket): rated at 300 V, 15 A, 105°C, 12-28 AWG (0.0804 mm<sup>2</sup> to 3.31 mm<sup>2</sup>) wire size, torque value 4.5 lb-in (0.509 N-m). The input terminal cable size: 14 AWG (2.1 mm<sup>2</sup>).

**ATTENTION**

For installations in hazardous locations (Class 1, Division 2):  
These devices are to be installed in an enclosure with a tool-removable cover or door, suitable for the environment.

**NOTE** This equipment is suitable for use in Class 1, Division 2, Groups A, B, C, D or nonhazardous locations only

**WARNING****EXPLOSION HAZARD**

Do not disconnect the equipment unless the power has been switched off, or the area is known to be nonhazardous.

**WARNING****EXPLOSION HAZARD**

The substitution of any components may impair suitability for Class 1, Division 2.

**WARNING**

EXPOSURE TO SOME CHEMICALS MAY DEGRADE THE SEALING PROPERTIES OF MATERIALS USED IN THE FOLLOWING DEVICE:  
Sealed Relay Device U21.

Moxa Inc.  
Fl. 4, No. 135, Lane 235, Baoqiao Rd.  
Xindian Dist., New Taipei City, 23145  
Taiwan, R.O.C.